

RF Power LDMOS Transistors

N-Channel Enhancement-Mode Lateral MOSFETs

These RF power transistors are designed for pulse applications operating at 960 to 1215 MHz. These devices are suitable for use in defense and commercial pulse applications with large duty cycles and long pulses, such as IFF, secondary surveillance radars, ADS-B transponders, DME and other complex pulse chains.

Typical Performance: In 1030–1090 MHz reference circuit, $I_{DQ(A+B)} = 100$ mA

Frequency (MHz) (1)	Signal Type	V _{DD} (V)	P _{out} (W)	G _{ps} (dB)	η _D (%)
1030	Pulse (128 μsec, 10% Duty Cycle)	50	800 Peak	17.5	52.1
1090			700 Peak	19.0	56.1
1030		52	850 Peak	17.5	51.7
1090			770 Peak	19.2	56.1

Typical Performance: In 960–1215 MHz reference circuit, $I_{DQ(A+B)} = 100$ mA

Frequency (MHz)	Signal Type	V _{DD} (V)	P _{out} (W)	G _{ps} (dB)	η _D (%)
960	Pulse (128 μsec, 4% Duty Cycle)	50	747 Peak	16.7	50.8
1030			713 Peak	16.5	49.7
1090			700 Peak	16.5	47.1
1215			704 Peak	16.5	54.5

Typical Performance: In 1030 MHz narrowband production test fixture, $I_{DQ(A+B)} = 100$ mA

Frequency (MHz)	Signal Type	V _{DD} (V)	P _{out} (W)	G _{ps} (dB)	η _D (%)
1030 (2)	Pulse (128 μsec, 10% Duty Cycle)	50	730 Peak	19.2	58.5

Narrowband Load Mismatch/Ruggedness

Frequency (MHz)	Signal Type	VSWR	P _{in} (W)	Test Voltage	Result
1030 (2)	Pulse (128 μsec, 10% Duty Cycle)	> 20:1 at All Phase Angles	17.2 Peak (3 dB Overdrive)	50	No Device Degradation

1. Measured in 1030–1090 MHz reference circuit (page 5).
2. Measured in 1030 MHz narrowband production test fixture (page 9).

Features

- Internally input and output matched for broadband operation and ease of use
- Device can be used in a single-ended, push-pull or quadrature configuration
- Qualified up to a maximum of 55 V_{DD} operation
- High ruggedness, handles > 20:1 VSWR
- Integrated ESD protection with greater negative gate-source voltage range for improved Class C operation and gate voltage pulsing
- Recommended drivers: MRFE6VS25N (25 W) or MRF6V10010N (10 W)
- Included in NXP product longevity program with assured supply for a minimum of 15 years after launch

AFV10700H
AFV10700HS
AFV10700GS

960–1215 MHz, 700 W PEAK, 52 V
AIRFAST RF POWER LDMOS
TRANSISTORS

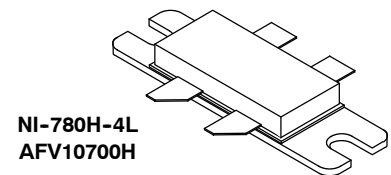

NI-780H-4L
AFV10700H

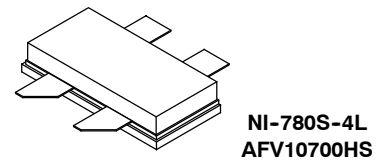

NI-780S-4L
AFV10700HS

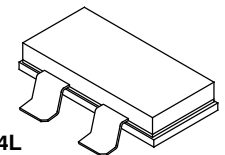

NI-780GS-4L
AFV10700GS

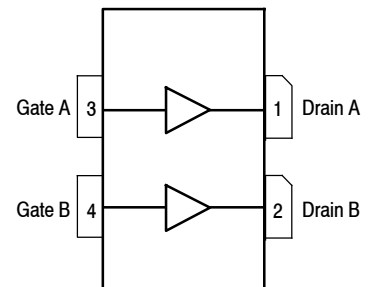

(Top View)

Note: The backside of the package is the source terminal for the transistor.

Figure 1. Pin Connections

Table 1. Maximum Ratings

Rating	Symbol	Value	Unit
Drain-Source Voltage	V_{DSS}	-0.5, +105	Vdc
Gate-Source Voltage	V_{GS}	-6.0, +10	Vdc
Operating Voltage	V_{DD}	55, +0	Vdc
Storage Temperature Range	T_{stg}	-65 to +150	°C
Case Operating Temperature Range	T_C	-55 to +150	°C
Operating Junction Temperature Range (1,2)	T_J	-55 to +225	°C
Total Device Dissipation @ $T_C = 25^\circ\text{C}$ Derate above 25°C	P_D	526 2.63	W W/°C

Table 2. Thermal Characteristics

Characteristic	Symbol	Value (2,3)	Unit
Thermal Impedance, Junction to Case Pulse: Case Temperature 75°C, 730 W Peak, 128 μsec Pulse Width, 10% Duty Cycle, 50 Vdc, $I_{DQ(A+B)} = 100\text{ mA}$, 1030 MHz	$Z_{\theta JC}$	0.030	°C/W

Table 3. ESD Protection Characteristics

Test Methodology	Class
Human Body Model (per JESD22-A114)	2, passes 2000 V
Charge Device Model (per JESD22-C101)	C3, passes 2000 V

Table 4. Electrical Characteristics ($T_A = 25^\circ\text{C}$ unless otherwise noted)

Characteristic	Symbol	Min	Typ	Max	Unit
----------------	--------	-----	-----	-----	------

Off Characteristics (4)

Gate-Source Leakage Current ($V_{GS} = 5\text{ Vdc}$, $V_{DS} = 0\text{ Vdc}$)	I_{GSS}	—	—	1	μAdc
Drain-Source Breakdown Voltage ($V_{GS} = 0\text{ Vdc}$, $I_D = 10\ \mu\text{A}$)	$V_{(BR)DSS}$	105	—	—	Vdc
Zero Gate Voltage Drain Leakage Current ($V_{DS} = 50\text{ Vdc}$, $V_{GS} = 0\text{ Vdc}$)	I_{DSS}	—	—	1	μAdc
Zero Gate Voltage Drain Leakage Current ($V_{DS} = 105\text{ Vdc}$, $V_{GS} = 0\text{ Vdc}$)	I_{DSS}	—	—	10	μAdc

On Characteristics

Gate Threshold Voltage (4) ($V_{DS} = 10\text{ Vdc}$, $I_D = 260\ \mu\text{Adc}$)	$V_{GS(th)}$	1.3	1.8	2.3	Vdc
Gate Quiescent Voltage ($V_{DD} = 50\text{ Vdc}$, $I_{DQ(A+B)} = 100\text{ mAdc}$, Measured in Functional Test)	$V_{GS(Q)}$	1.6	2.1	2.6	Vdc
Drain-Source On-Voltage (4) ($V_{GS} = 10\text{ Vdc}$, $I_D = 2.6\text{ Adc}$)	$V_{DS(on)}$	—	0.28	—	Vdc

Dynamic Characteristics (4,5)

Reverse Transfer Capacitance ($V_{DS} = 50\text{ Vdc} \pm 30\text{ mV(rms)ac}$ @ 1 MHz, $V_{GS} = 0\text{ Vdc}$)	C_{rss}	—	1.16	—	pF
---	-----------	---	------	---	----

1. Continuous use at maximum temperature will affect MTTF.
2. MTTF calculator available at <http://www.nxp.com>.
3. Refer to AN1955, *Thermal Measurement Methodology of RF Power Amplifiers*. Go to <http://www.nxp.com/RF> and search for AN1955.
4. Each side of device measured separately.
5. Part internally matched both on input and output.

(continued)

Table 4. Electrical Characteristics ($T_A = 25^\circ\text{C}$ unless otherwise noted) (continued)

Characteristic	Symbol	Min	Typ	Max	Unit
Functional Tests (In NXP Narrowband Production Test Fixture, 50 ohm system) $V_{DD} = 50\text{ Vdc}$, $I_{DQ(A+B)} = 100\text{ mA}$, $P_{out} = 730\text{ W Peak}$ (73 W Avg.), $f = 1030\text{ MHz}$, 128 μsec Pulse Width, 10% Duty Cycle					
Power Gain	G_{ps}	18.0	19.2	21.0	dB
Drain Efficiency	η_D	54.5	58.5	—	%
Input Return Loss	IRL	—	-15	-9	dB

Load Mismatch/Ruggedness (In NXP Narrowband Production Test Fixture, 50 ohm system) $I_{DQ(A+B)} = 100\text{ mA}$

Frequency (MHz)	Signal Type	VSWR	P_{in} (W)	Test Voltage, V_{DD}	Result
1030	Pulse (128 μsec , 10% Duty Cycle)	> 20:1 at All Phase Angles	17.2 Peak (3 dB Overdrive)	50	No Device Degradation

Table 5. Ordering Information

Device	Tape and Reel Information	Package
AFV10700HR5	R5 Suffix = 50 Units, 56 mm Tape Width, 13-inch Reel	NI-780H-4L
AFV10700HSR5	R5 Suffix = 50 Units, 32 mm Tape Width, 13-inch Reel	NI-780S-4L
AFV10700GSR5		NI-780GS-4L

TYPICAL CHARACTERISTICS

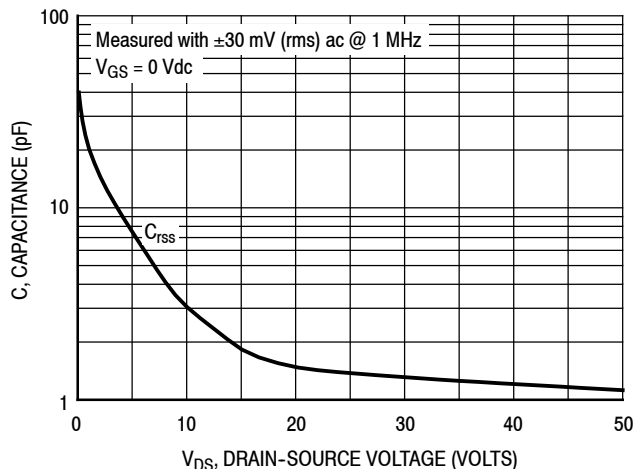

Note: Each side of device measured separately.

Figure 2. Capacitance versus Drain-Source Voltage

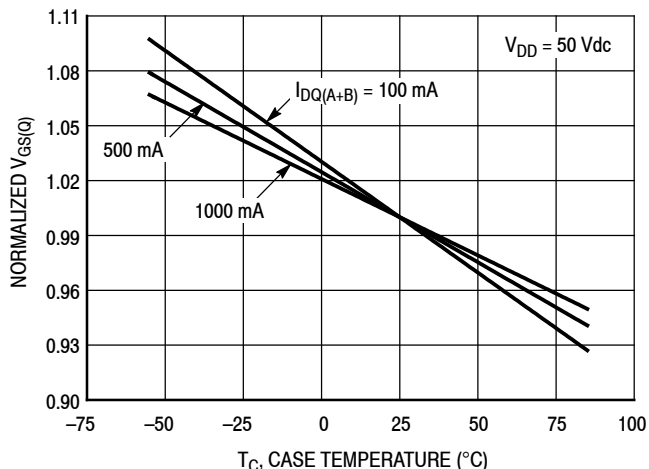

I_{DQ} (mA)	Slope (mV/°C)
100	-2.73
500	-2.39
1500	-2.09

Figure 3. Normalized V_{GS} versus Quiescent Current and Case Temperature

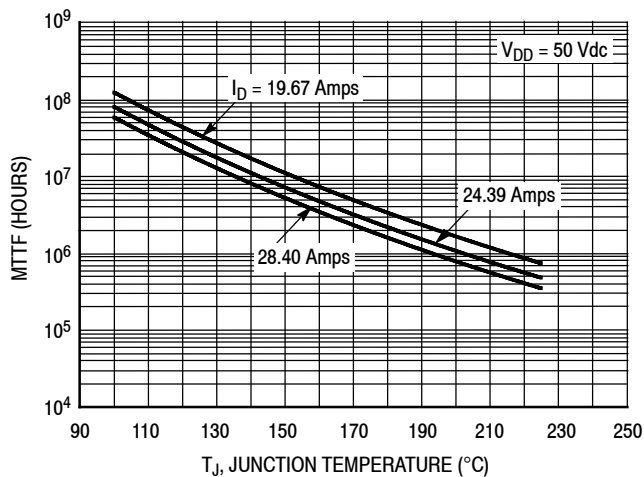

Note: MTTF value represents the total cumulative operating time under indicated test conditions.

MTTF calculator available at <http://www.nxp.com>.

Figure 4. MTTF versus Junction Temperature – Pulse

1030–1090 MHz REFERENCE CIRCUIT – 2.0" x 3.0" (5.1 cm x 7.6 cm)

Table 6. 1030–1090 MHz Performance (In NXP Reference Circuit, 50 ohm system) $I_{DQ(A+B)} = 100 \text{ mA}$

Frequency (MHz)	Signal Type	V _{DD} (V)	P _{out} (W)	G _{ps} (dB)	η_D (%)
1030	Pulse (128 μ sec, 10% Duty Cycle)	50	800 Peak	17.5	52.1
1090			700 Peak	19.0	56.1
1030		52	850 Peak	17.5	51.7
1090			770 Peak	19.2	56.1

NOTE: Size of the matching area: 1.3" x 2.6" (3.3 cm x 6.6 cm)

1030–1090 MHz REFERENCE CIRCUIT – 2.0" × 3.0" (5.1 cm × 7.6 cm)

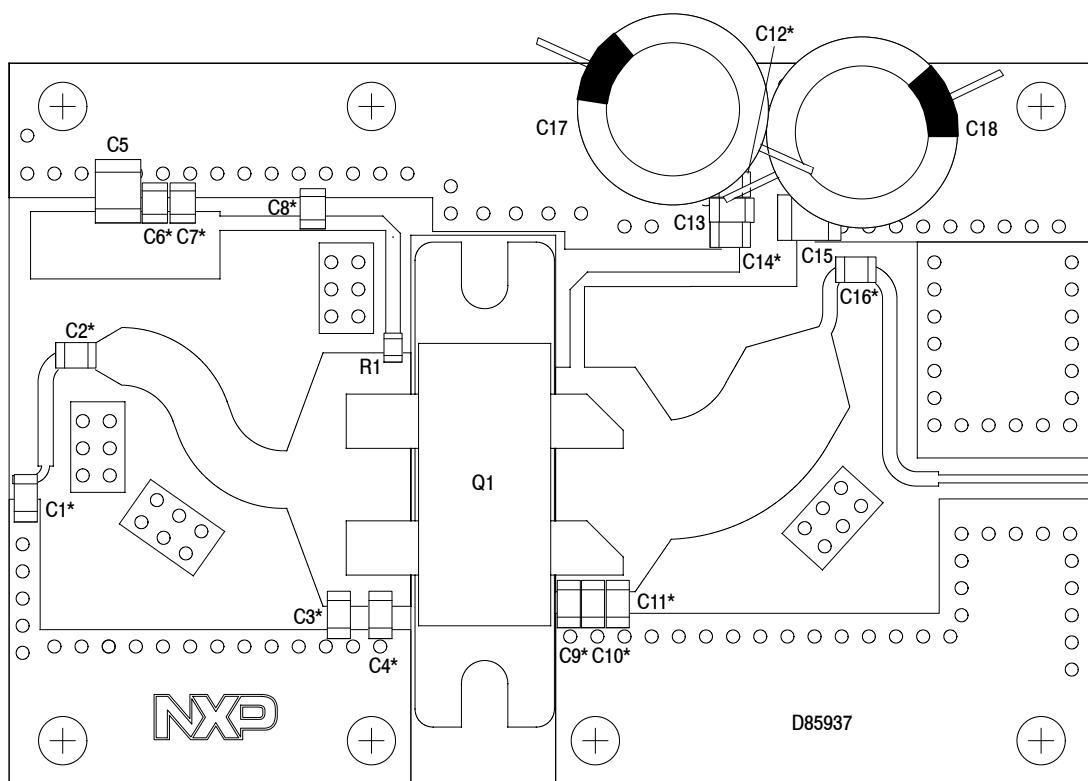

*C1, C2, C3, C4, C6, C7, C8, C9, C10, C11, C12, C14 and C16 are mounted vertically.

Figure 5. AFV10700H Reference Circuit Component Layout – 1030–1090 MHz

Table 7. AFV10700H Reference Circuit Component Designations and Values – 1030–1090 MHz

Part	Description	Part Number	Manufacturer
C1	1.5 pF Chip Capacitor	ATC800B1R5BT500XT	ATC
C2, C8, C14	39 pF Chip Capacitor	ATC800B390JT500XT	ATC
C3, C4	4.3 pF Chip Capacitor	ATC800B4R3CT500XT	ATC
C5, C15	2.2 μ F Chip Capacitor	C3225X7R2A225K230AB	TDK
C6, C12	1000 pF Chip Capacitor	ATC800B102JT50XT	ATC
C7	100 pF Chip Capacitor	ATC800B101JT500XT	ATC
C9	4.7 pF Chip Capacitor	ATC800B4R7CT500XT	ATC
C10, C11	3.3 pF Chip Capacitor	ATC800B3R3CT500XT	ATC
C13	1.0 μ F Chip Capacitor	GRM31CR72A105KA01L	Murata
C16	270 pF Chip Capacitor	ATC800B271JT200XT	ATC
C17, C18	470 μ F, 63 V Electrolytic Capacitor	MCGPR63V477M13X26–RH	Multicom
Q1	RF High Power LDMOS Transistor	AFV10700H	NXP
R1	22 Ω , 1/8 W Chip Resistor	RK73H2ATTD22R0F	KAO Speer
PCB	Rogers RO3010 0.025", $\epsilon_r = 11.2$	D85937	MTL

**TYPICAL CHARACTERISTICS – 1030–1090 MHz
REFERENCE CIRCUIT**

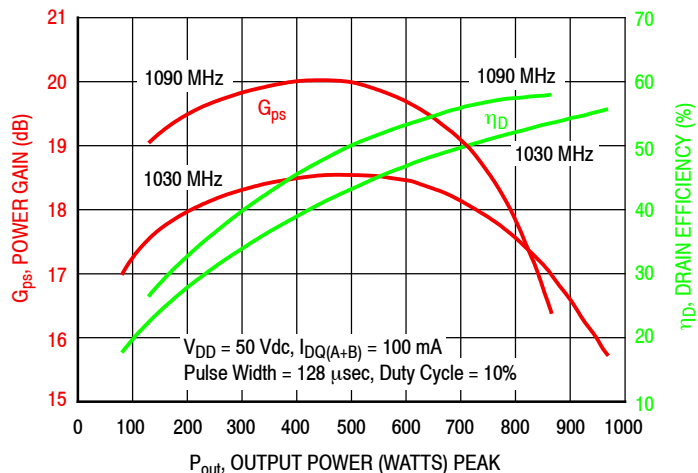

Figure 6. Power Gain and Drain Efficiency versus Output Power – 50 V

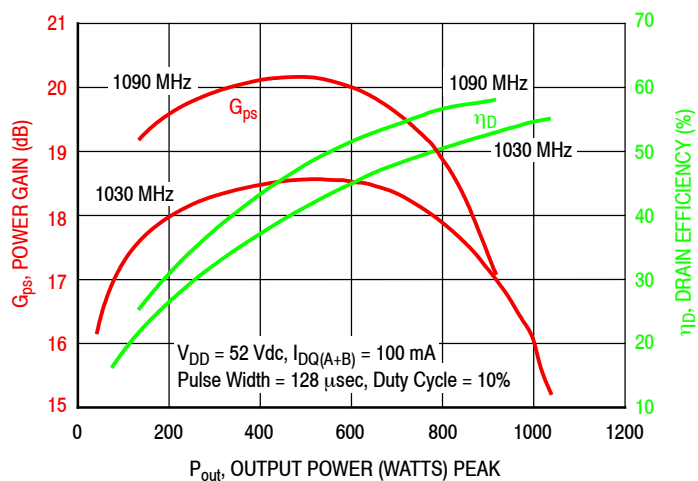
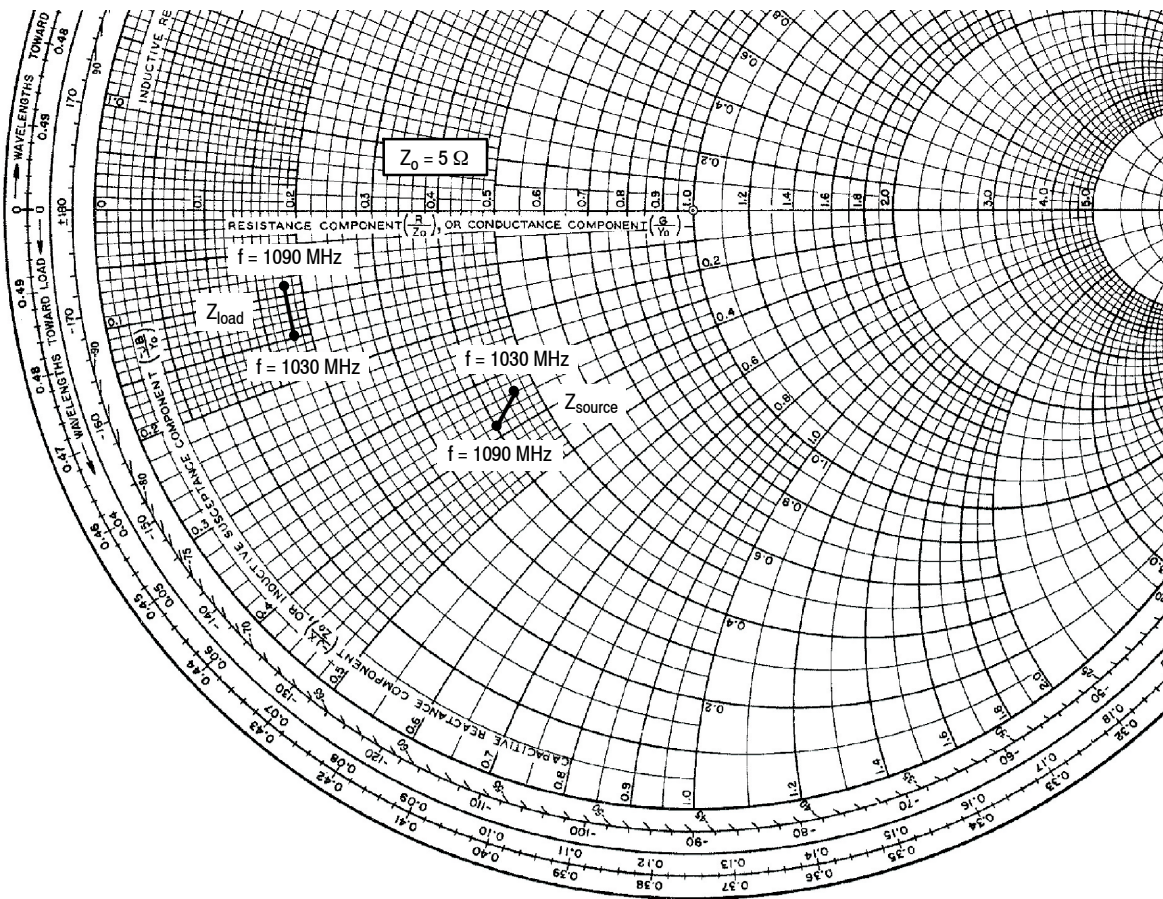

Figure 7. Power Gain and Drain Efficiency versus Output Power – 52 V

1030–1090 MHz REFERENCE CIRCUIT



f MHz	Z _{source} Ω	Z _{load} Ω
1030	2.3 – j1.7	0.91 – j0.76
1090	2.0 – j1.9	0.88 – j0.47

Z_{source} = Test circuit impedance as measured from gate to ground.

Z_{load} = Test circuit impedance as measured from drain to ground.

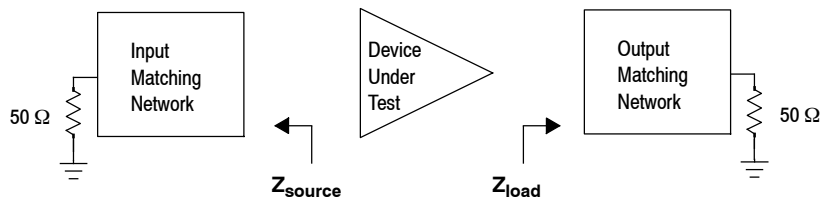
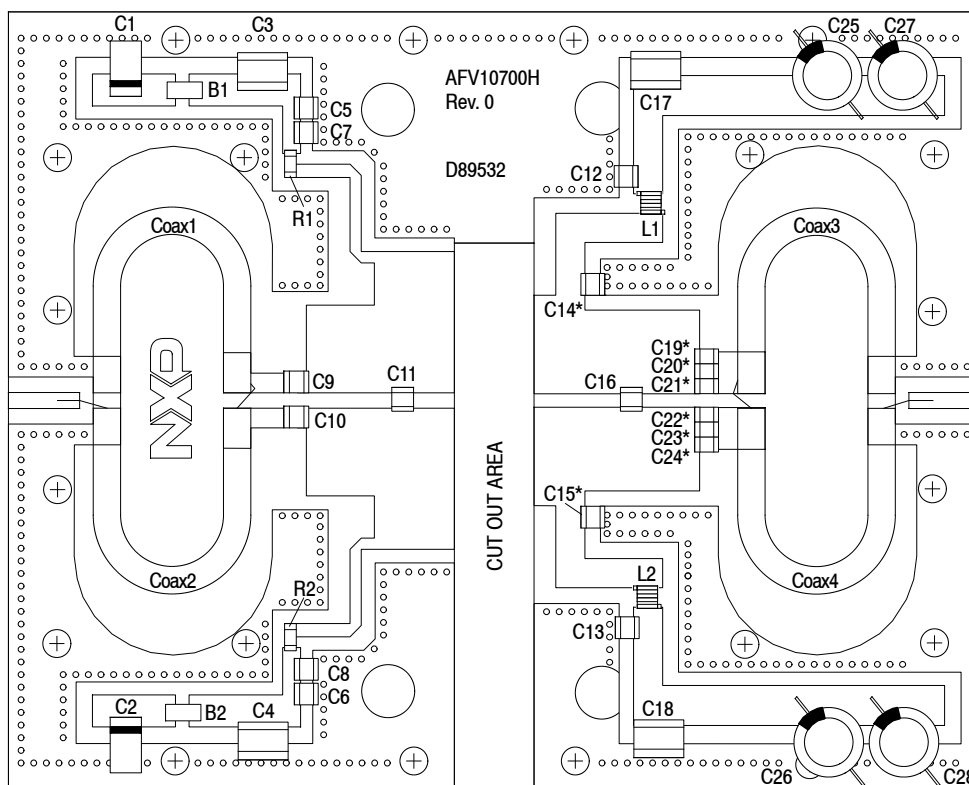

Figure 8. Series Equivalent Source and Load Impedance – 1030–1090 MHz

1030 MHz NARROWBAND PRODUCTION TEST FIXTURE – 4.0" x 5.0" (10.2 cm x 12.7 cm)



*C14, C15, C19, C20, C21, C22, C23 and C24 are mounted vertically.

Figure 9. AFV10700H Narrowband Test Circuit Component Layout – 1030 MHz

Table 8. AFV10700H Narrowband Test Circuit Component Designations and Values – 1030 MHz

Part	Description	Part Number	Manufacturer
B1, B2	Short RF Bead	2743019447	Fair-Rite
C1, C2	22 μ F, 35 V Tantalum Capacitor	T491X226K035AT	Kemet
C3, C4	2.2 μ F Chip Capacitor	C1825C225J5RAC	Kemet
C5, C6	0.1 μ F Chip Capacitor	CDR33BX104AKWS	AVX
C7, C8, C19, C20, C21, C22, C23, C24	43 pF Chip Capacitor	ATC100B430JT500XT	ATC
C9, C10	3.3 pF Chip Capacitor	ATC100B3R3CT500XT	ATC
C11	0.7 pF Chip Capacitor	ATC100B0R7BT500XT	ATC
C12, C13	36 pF Chip Capacitor	ATC100B360JT500XT	ATC
C14, C15	5.1 pF Chip Capacitor	ATC100B5R1CT500XT	ATC
C16	5.6 pF Chip Capacitor	ATC100B5R6CT500XT	ATC
C17, C18	0.01 μ F Chip Capacitor	C1825C103K1GACTU	Kemet
C25, C26, C27, C28	470 μ F, 63 V Electrolytic Capacitor	MCGPR63V477M13X26-RH	Multicomp
Coax1, Coax2, Coax3, Coax4	35 Ω , Semi Rigid Coax 1.98" Shield Length	HSF-141-35-C	Hongsen Cable
L1, L2	12 nH Inductor, 3 Turns	GA3094-ALC	Coilcraft
R1, R2	5.6 Ω , 1/4 W Chip Resistor	CRCW12065R60FKEA	Vishay
PCB	Arlon, AD255A, 0.03", $\epsilon_r = 2.55$	D89532	MTL

**TYPICAL CHARACTERISTICS – 1030 MHz, $T_C = 25^\circ\text{C}$
PRODUCTION TEST FIXTURE**

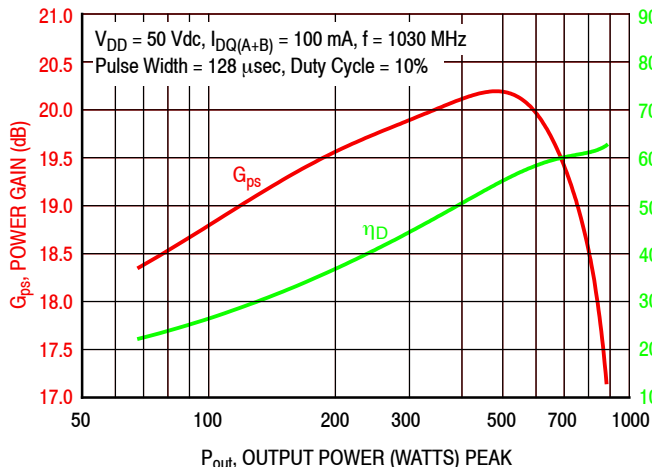

Figure 10. Power Gain and Drain Efficiency versus Output Power

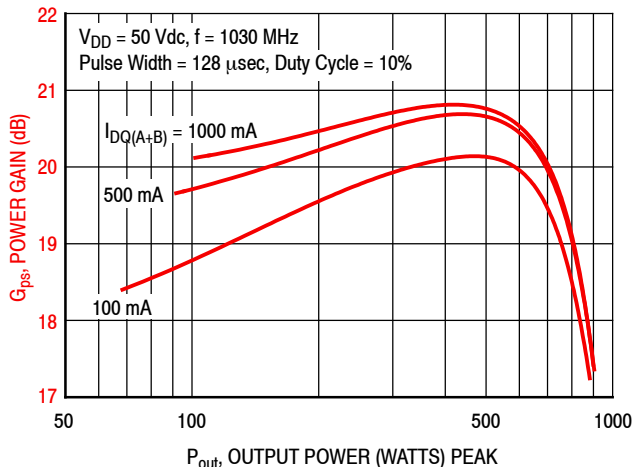

Figure 11. Power Gain versus Output Power and Quiescent Drain Current

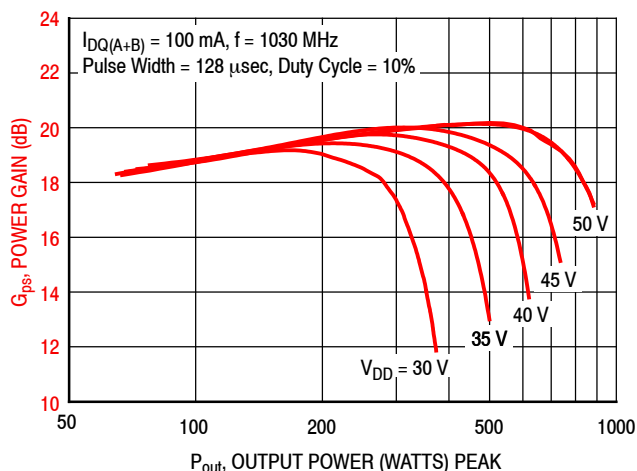
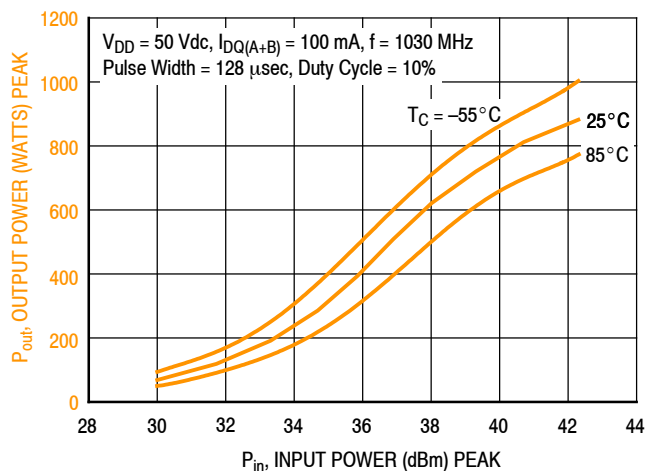

Figure 12. Power Gain versus Output Power and Drain Voltage



f (MHz)	P1dB (W)	P3dB (W)
1030	740	883

Figure 13. Output Power versus Input Power

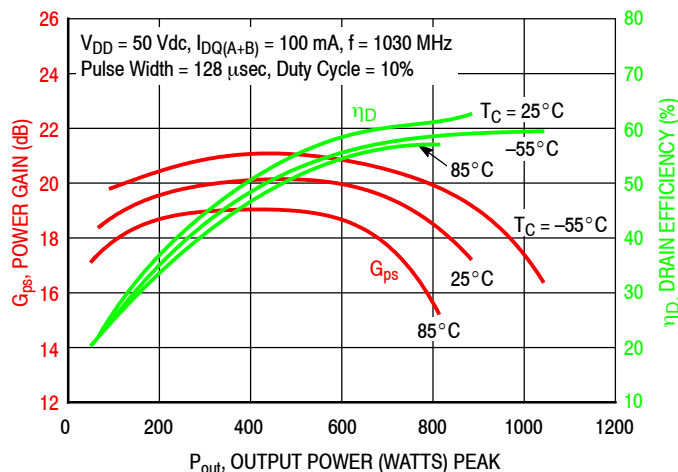

Figure 14. Power Gain and Drain Efficiency versus Output Power

1030 MHz NARROWBAND PRODUCTION TEST FIXTURE

f MHz	Z_{source} Ω	Z_{load} Ω
1030	$4.0 - j6.9$	$3.9 - j1.4$

Z_{source} = Test circuit impedance as measured from gate to gate, balanced configuration.

Z_{load} = Test circuit impedance as measured from drain to drain, balanced configuration.

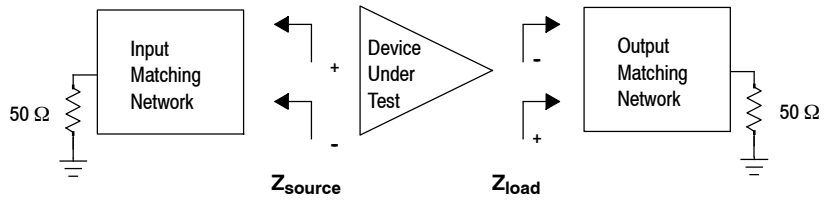
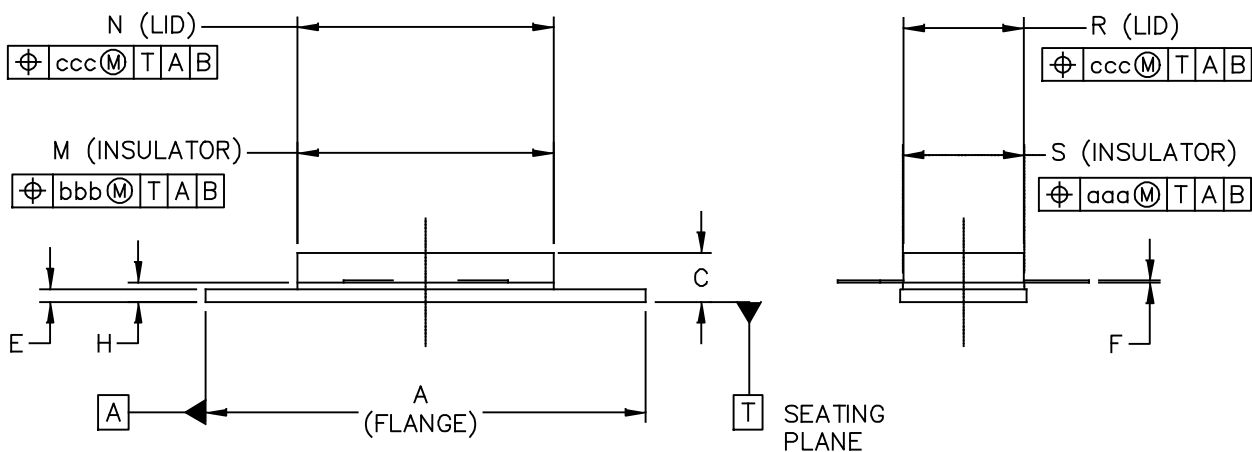
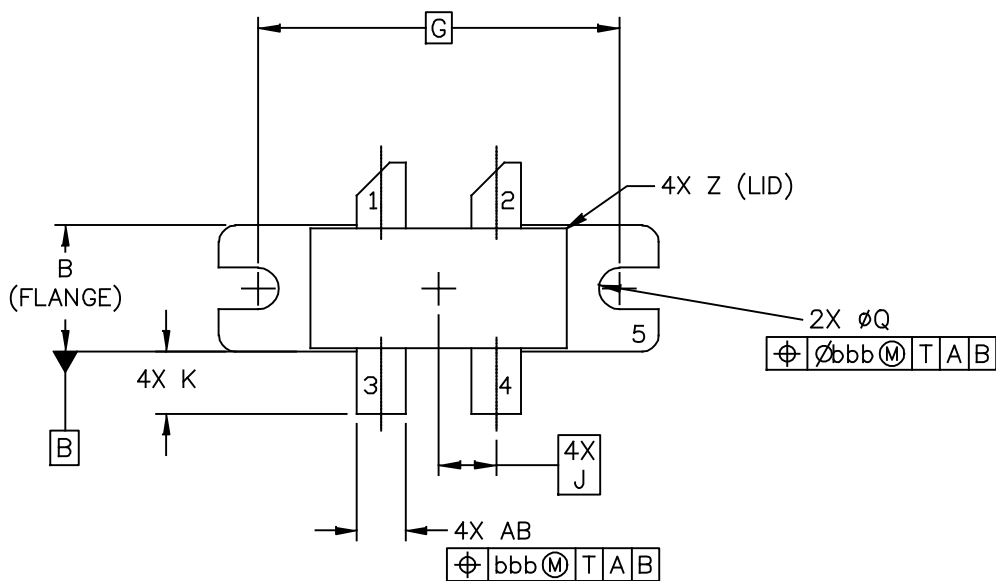

Figure 15. Series Equivalent Source and Load Impedance – 1030 MHz

PACKAGE DIMENSIONS



© NXP SEMICONDUCTORS N.V. ALL RIGHTS RESERVED	MECHANICAL OUTLINE	PRINT VERSION NOT TO SCALE
TITLE: NI 780-4	DOCUMENT NO: 98ASA10793D	REV: A
	STANDARD: NON-JEDEC	
	SOT1827-1	17 MAR 2016

NOTES:

1. DIMENSIONING AND TOLERANCING PER ANSI Y14.5M-1994.
2. CONTROLLING DIMENSION: INCH.
3. DIMENSION H IS MEASURED .030 (0.762) AWAY FROM PACKAGE BODY.

STYLE 1:

- PIN 1. DRAIN
 2. DRAIN
 3. GATE
 4. GATE
 5. SOURCE

DIM	INCH		MILLIMETER		DIM	INCH		MILLIMETER	
	MIN	MAX	MIN	MAX		MIN	MAX	MIN	MAX
A	1.335	1.345	33.91	34.16	R	.365	.375	9.27	9.53
B	.380	.390	9.65	9.91	S	.365	.375	9.27	9.52
C	.125	.170	3.18	4.32	U		.040		1.02
E	.035	.045	0.89	1.14	Z		.030		0.76
F	.003	.006	0.08	0.15	AB	.145	.155	3.68	3.94
G	1.100 BSC		27.94 BSC						
H	.057	.067	1.45	1.7	aaa		.005		0.127
J	.175 BSC		4.44 BSC		bbb		.010		0.254
K	.170	.210	4.32	5.33	ccc		.015		0.381
M	.774	.786	19.61	20.02					
N	.772	.788	19.61	20.02					
Q	Ø.118	Ø.138	Ø3	Ø3.51					
© NXP SEMICONDUCTORS N. V. ALL RIGHTS RESERVED			MECHANICAL OUTLINE			PRINT VERSION NOT TO SCALE			
TITLE: NI 780-4					DOCUMENT NO: 98ASA10793D REV: A				
					STANDARD: NON-JEDEC				
					SOT1827-1			17 MAR 2016	

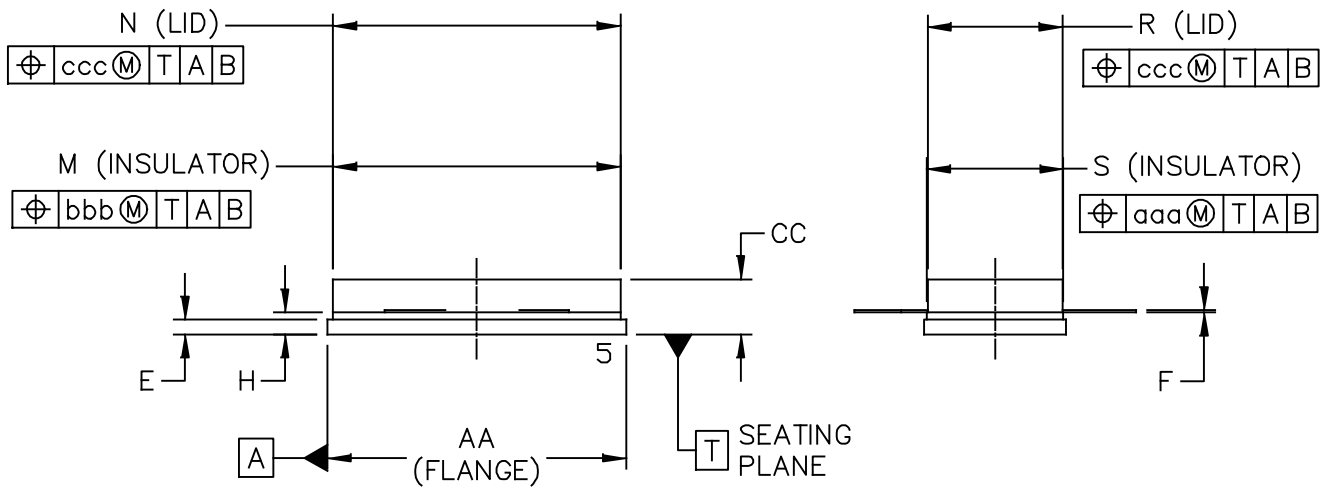
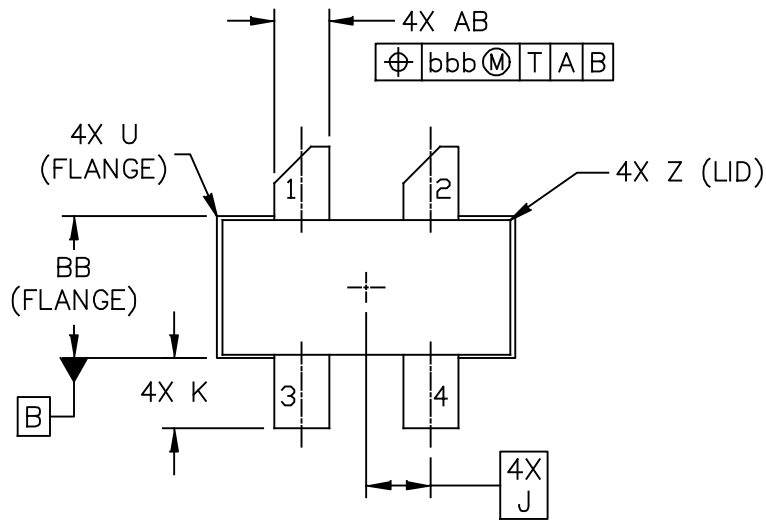

© NXP SEMICONDUCTORS N.V. ALL RIGHTS RESERVED	MECHANICAL OUTLINE	PRINT VERSION NOT TO SCALE
TITLE: NI-780S-4L	DOCUMENT NO: 98ASA10718D STANDARD: NON-JEDEC SOT1826-1	REV: C 01 AUG 2016

NOTES:

1. DIMENSIONING AND TOLERANCING PER ANSI Y14.5M-1994.
2. CONTROLLING DIMENSION: INCH.
3. DELETED
4. DIMENSION H IS MEASURED .030 (0.762) AWAY FROM FLANGE TO CLEAR EPOXY FLOW OUT PARALLEL TO DATUM B.

DIM	INCH		MILLIMETER		DIM	INCH		MILLIMETER		
	MIN	MAX	MIN	MAX		MIN	MAX	MIN	MAX	
AA	.805	.815	20.45	20.70	U		.040		1.02	
BB	.382	.388	9.70	9.86	Z		.030		0.76	
CC	.125	.170	3.18	4.32	AB	.145	.155	3.68	– 3.94	
E	.035	.045	0.89	1.14						
F	.003	.006	0.08	0.15	aaa		.005		0.127	
H	.057	.067	1.45	1.70	bbb		.010		0.254	
J	.175 BSC		4.44 BSC		ccc		.015		0.381	
K	.170	.210	4.32	5.33						
M	.774	.786	19.61	20.02						
N	.772	.788	19.61	20.02						
R	.365	.375	9.27	9.53						
S	.365	.375	9.27	9.52						
© NXP SEMICONDUCTORS N. V. ALL RIGHTS RESERVED			MECHANICAL OUTLINE			PRINT VERSION NOT TO SCALE				
TITLE:					DOCUMENT NO: 98ASA10718D REV: C					
NI-780S-4L					STANDARD: NON-JEDEC					
					SOT1826-1		01 AUG 2016			

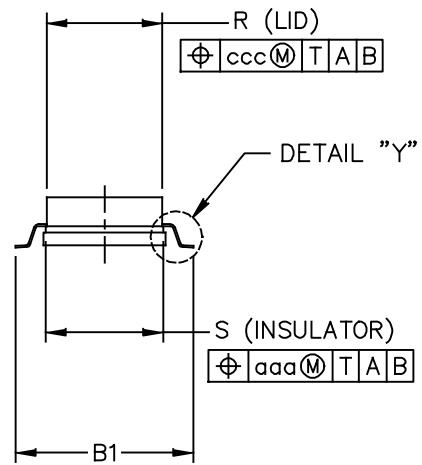
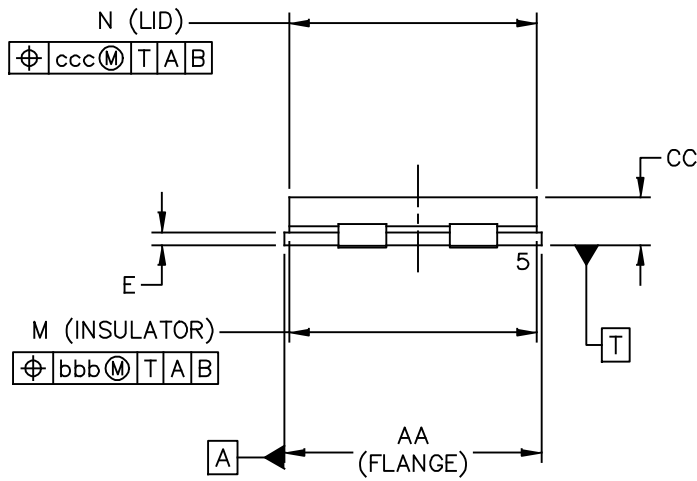
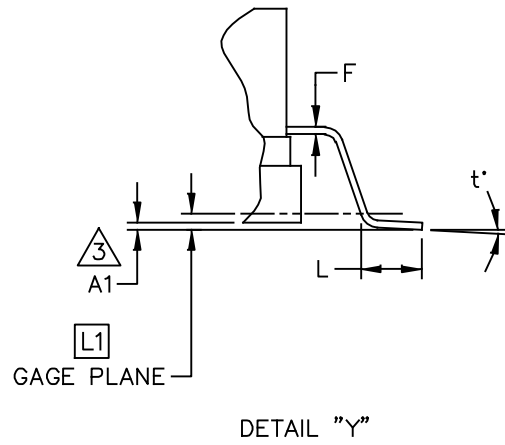
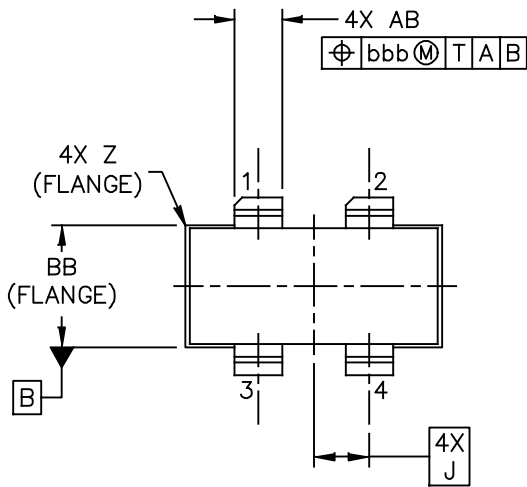

© NXP SEMICONDUCTORS N.V. ALL RIGHTS RESERVED	MECHANICAL OUTLINE	PRINT VERSION NOT TO SCALE
TITLE: NI-780GS-4L	DOCUMENT NO: 98ASA00238D	REV: C
	STANDARD: NON-JEDEC	
	SOT1805-1	23 FEB 2016

NOTES:

1. DIMENSIONING AND TOLERANCING PER ANSI Y14.5M-1994.
2. CONTROLLING DIMENSION: INCH.

3. DIMENSION A1 IS MEASURED WITH REFERENCE TO DATUM T. THE POSITIVE VALUE IMPLIES THAT THE PACKAGE BOTTOM IS HIGHER THAN THE LEAD BOTTOM.

DIM	INCH		MILLIMETER		DIM	INCH		MILLIMETER	
	MIN	MAX	MIN	MAX		MIN	MAX	MIN	MAX
AA	.805	.815	20.45	20.70	Z	R.000	R.040	R0.00	R1.02
A1	.002	.008	0.05	0.20	AB	.145	.155	3.68	3.94
BB	.380	.390	9.65	9.91	t°	0°	8°	0°	8°
B1	.546	.562	13.87	14.27	aaa	.005		0.13	
CC	.125	.170	3.18	4.32	bbb	.010		0.25	
E	.035	.045	0.89	1.14	ccc	.015		0.38	
F	.003	.006	0.08	0.15					
L	.038	.046	0.97	1.17					
L1	.010 BSC		0.25 BSC						
J	.175 BSC		4.44 BSC						
M	.774	.786	19.66	19.96					
N	.772	.788	19.61	20.02					
R	.365	.375	9.27	9.53					
S	.365	.375	9.27	9.53					

© NXP SEMICONDUCTORS N. V. ALL RIGHTS RESERVED		MECHANICAL OUTLINE	PRINT VERSION NOT TO SCALE
TITLE:		DOCUMENT NO: 98ASA00238D	REV: C
NI-780GS-4L		STANDARD: NON-JEDEC	
		SOT1805-1	23 FEB 2016

PRODUCT DOCUMENTATION, SOFTWARE AND TOOLS

Refer to the following resources to aid your design process.

Application Notes

- AN1908: Solder Reflow Attach Method for High Power RF Devices in Air Cavity Packages
- AN1955: Thermal Measurement Methodology of RF Power Amplifiers

Engineering Bulletins

- EB212: Using Data Sheet Impedances for RF LDMOS Devices

Software

- Electromigration MTTF Calculator
- RF High Power Model
- .s2p File

Development Tools

- Printed Circuit Boards

REVISION HISTORY

The following table summarizes revisions to this document.

Revision	Date	Description
0	May 2017	<ul style="list-style-type: none">• Initial release of data sheet
1	Jan. 2018	<ul style="list-style-type: none">• Added part number AFV10700GS, p. 1• Production test fixture, Typical Characteristic graphs: clarified temperature condition, p. 10• Added NI-780GS-4L package isometric, p. 1, and Mechanical Outline, pp. 16–17
2	Aug. 2019	<ul style="list-style-type: none">• Overview copy and device description: updated to reflect frequency band operation from 960–1215 MHz, p. 1• Typical Performance table: added 960–1215 MHz performance data, p. 1• Table 6, 1030–1090 Component Layout Parts List: updated the part number and description for C16 and R1, p. 6

How to Reach Us:

Home Page:
nxp.com

Web Support:
nxp.com/support

Information in this document is provided solely to enable system and software implementers to use NXP products. There are no express or implied copyright licenses granted hereunder to design or fabricate any integrated circuits based on the information in this document. NXP reserves the right to make changes without further notice to any products herein.

NXP makes no warranty, representation, or guarantee regarding the suitability of its products for any particular purpose, nor does NXP assume any liability arising out of the application or use of any product or circuit, and specifically disclaims any and all liability, including without limitation consequential or incidental damages. "Typical" parameters that may be provided in NXP data sheets and/or specifications can and do vary in different applications, and actual performance may vary over time. All operating parameters, including "typicals," must be validated for each customer application by customer's technical experts. NXP does not convey any license under its patent rights nor the rights of others. NXP sells products pursuant to standard terms and conditions of sale, which can be found at the following address: nxp.com/SalesTermsandConditions.

NXP, the NXP logo and Airfast are trademarks of NXP B.V. All other product or service names are the property of their respective owners.

© 2017–2019 NXP B.V.

Mouser Electronics

Authorized Distributor

Click to View Pricing, Inventory, Delivery & Lifecycle Information:

[NXP:](#)

[AFV10700HSR5](#) [AFV10700HR5](#) [AFV10700H-1090](#) [AFV10700GSR5](#)